

ÖKO_LAVAMAT 1571 TURBO SENSORTRONIC

The environmentally friendly washer-dryer

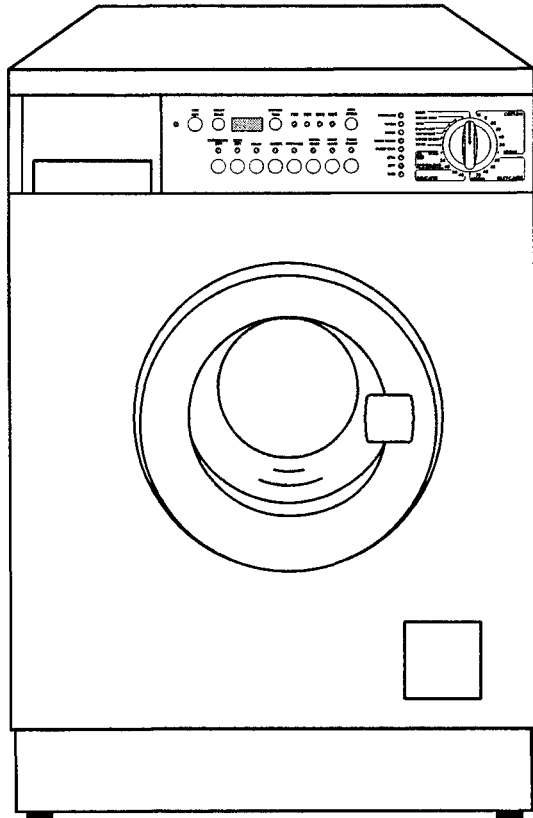

Instruction booklet

Dear customer,

Please read these operating instructions carefully and pay particular attention to the safety notes indicated in the first pages. We recommend that you keep this instruction booklet for future reference and pass it on to any future owners.



The warning triangle and/or the key words (Warning!, Caution!) emphasize information that is particularly important for your safety or correct functioning of the appliance.



This symbol guides you, step by step, in the operation of the appliance.



The information marked with this symbol provides additional instructions and practical tips on the use of the appliance.



Tips and information about economical and ecological use of the machine are marked with the clover symbol.

If you require assistance or advice on your appliance, please contact our customer care department by letter or telephone:

Customer Care Department
AEG Domestic Appliances Limited
P.O. Box 47
Newbury
Berkshire RG14 5XL
Tel: 01635 572700
Fax: 01635 42970

Printed on recycled paper.
People who think ecologically, act accordingly...

Contents

Safety instructions	6
Disposal	8
Tips for environmental protection	9
Main features of your washer-dryer	10
Description of the appliance	11
Control panel	12
Programme selector dial	12
ON/OFF button	13
Mains-on light	13
START/PAUSE button	13
DELAY START button	13
ELECTRONIC DRYING buttons	14
DRYING TIME button	14
Programme Option buttons	14
STAIN	14
QUICK	14
PREWASH	15
EXTRA RINSE	15
RINSE HOLD	15
SPIN SPEED	16
Display	16
Programme progress display	16
Cancelling a programme	17
Altering a programme which is running	17
Opening the door after the programme has started	17
Detergent dispenser drawer	18
Before the first wash	18
Preparing the wash cycle	19
Sorting out and preparing the laundry	19
Weight of laundry	20
Types of fabric and care labels	20
Detergents and additives	22
Which detergent?.....	22
WHITES	22
NON BIOLOGICAL	22
COLOURED	22
DELICATE ITEMS	22
LAUNDRY BLEACH	22
STAIN REMOVER	22

And in which form?	23
TRADITIONAL POWDERS	23
TRADITIONAL LIQUIDS.	23
COMPACT POWDERS AND LIQUIDS	23
FABRIC CONDITIONERS.	23
Preparing the drying cycle	24
Load	24
Garments not suitable for drying	24
Drying symbols on garment labels	25
Duration of the drying cycle	25
Modification of the drying time	25
Fibre residue.	25
Additional drying	26
Automatic washing and drying (NON-STOP programme).	26
How to wash	27
Load the laundry	27
Add detergent and additive.	27
Switching the machine on.	27
Selection of the desired wash programme	28
Selection of the spin speed	28
Selection of the STAIN, PREWASH or QUICK WASH option.	28
Selection of the EXTRA RINSE and/or RINSE HOLD option.	28
Selection of the DELAY START option	29
Starting the programme	29
At the end of the programme	30
How to dry.	31
Drying only.	31
Automatic washing and drying (NON-STOP programme).	31
Programme charts	32-33
Programme chart	34
Timed drying	34
Cleaning and maintenance	35
After each wash	35
Periodical cleaning.	35
Exterior	35
Detergent dispenser drawer	35
Drain filter.	36
Water inlet filter.	36
Emergency emptying out.	37
Frost precautions	37

Something not working?	38
Troubleshooting.....	38
Unsatisfactory washing results.....	42
Technical data	43
Service & Spare Parts	44
Guarantee Conditions	46-47
Instructions for installation and electrical connection	48
Safety instructions for the installer.....	48
Dimensions of the appliance	49
Front view and side view.....	49
Rear view.....	49
Installation	50
Unpacking.....	50
Positioning.....	51
Levelling.....	51
Water inlet (cold water connection only).....	52
Water drainage.....	52
In the interest of the environment.....	53
Electrical connections.....	54
Permanent connection.....	55



Safety instructions

Your safety is of paramount importance, please ensure you read this instruction book before installing or using this appliance.

General safety

- Repairs to the machine must be carried out only by qualified personnel. Repairs carried out by inexperienced persons could cause injury or serious malfunctioning. Contact your local AEG Service Force Centre.
- Never start the machine if the mains cable is damaged or the control panel or worktop are damaged allowing inner components to be accessible.
- Unplug the appliance before carrying out any cleaning or maintenance operations.
- Never pull the mains cable to remove the plug from the socket; always take hold of the plug itself.
- During high temperature wash programmes and during the drying cycle, the door glass may get hot.
- Let the water cool down before carrying out emergency emptying or before opening the door in an emergency.

Installation

- Follow the installation instructions **carefully**.
- Carry out a first wash without laundry (COTTONS 60, with half the amount of detergent) in order to remove any manufacturing residue from the tub and the drum.

Child safety

- This appliance is designed to be operated by adults. Children should not be allowed to tamper with the controls or play with the appliance.
- Pets and children have been known to climb into washing machines. Please check the drum before use.
- Keep all packaging well away from children.
- Keep all detergents in a safe place out of children's reach.
- Make sure that children or pets do not climb into the drum.
- When disposing of the appliance, cut off the mains cable, and destroy the plug. Disable the door catch to prevent young children being trapped inside.

During use

- Always unplug the appliance and turn off the water tap after use.
- This appliance is designed for domestic use only. If the machine is used for any other purposes or is not used correctly, the manufacturer accepts no responsibility for any possible damage that might occur.
- For safety reasons, the appliance must not be modified.
- Use only detergents suitable for washing machines and follow the manufacturer's instructions.
- Garments which have been in contact with flammable solvents should not be machine washed.
- Dyes and bleaching agents may only be used if specifically permitted by the manufacturer of these products. We cannot be held liable for any damage.



Disposal

Packaging materials

The materials marked with the symbol ♻ are recyclable.

>PE<=polyethylene

>PS<=polystyrene

>PP<=polypropylene

This means that they can be recycled by disposing of them properly in appropriate collection containers.

Machine

Use authorised disposal sites for your old appliance. Help to keep your country tidy!



Tips for environmental protection

To save water, energy and to help protect the environment, we recommend that you follow these tips:

- Normally soiled laundry may be washed without prewashing in order to save detergent, water and time (the environment is protected too!).
- Use the energy saving programme when washing normally soiled garments.
- The machine works more economically if it is fully loaded (for both washing and drying cycles).
- When small loads are washed, use only half to two thirds of the recommended amount of detergent.
- The machine will consume less energy if the laundry is **adequately spun** before being dried.
- With adequate pre-treatment, stains and limited soiling can be removed; the laundry can then be washed at a lower temperature.

Main features of your washer-dryer

- Programme and temperature setting using the programme selector.
- **Stain programme** for effectively treating stained washing.
- **Energy saving programme** for normally soiled cotton items.
- **Speed for the final spin** can be reduced to 1200, 900 or 700 rpm.
- **RINSE HOLD**: the laundry is left immersed in the final rinse water to prevent creasing.
- **Delay timer**: programme start can be delayed by 1 to 19 hours (e.g. to times with a more economical power rate).
- **Programme progress display** showing the programme steps selected and the programme phase which is running.
- Because of its gentle washing action, the **special wool cycle** washes your garments with extreme care.
- **The drying programmes** will enable you to have dry and soft laundry in a short time.
- **3-compartment drawer** for detergent and fabric softener.

Important

Your machine is fitted with a balance control device, which ensures the machine is stable during the spin.

If the wash load appears not to have been spun sufficiently at the end of the wash cycle, because it is not evenly distributed in the drum, the balance control device may have operated. It will therefore be necessary to redistribute the wash load manually and select a spin programme. For more detailed information see the section headed "Something Not Working".

Description of the appliance

Front view

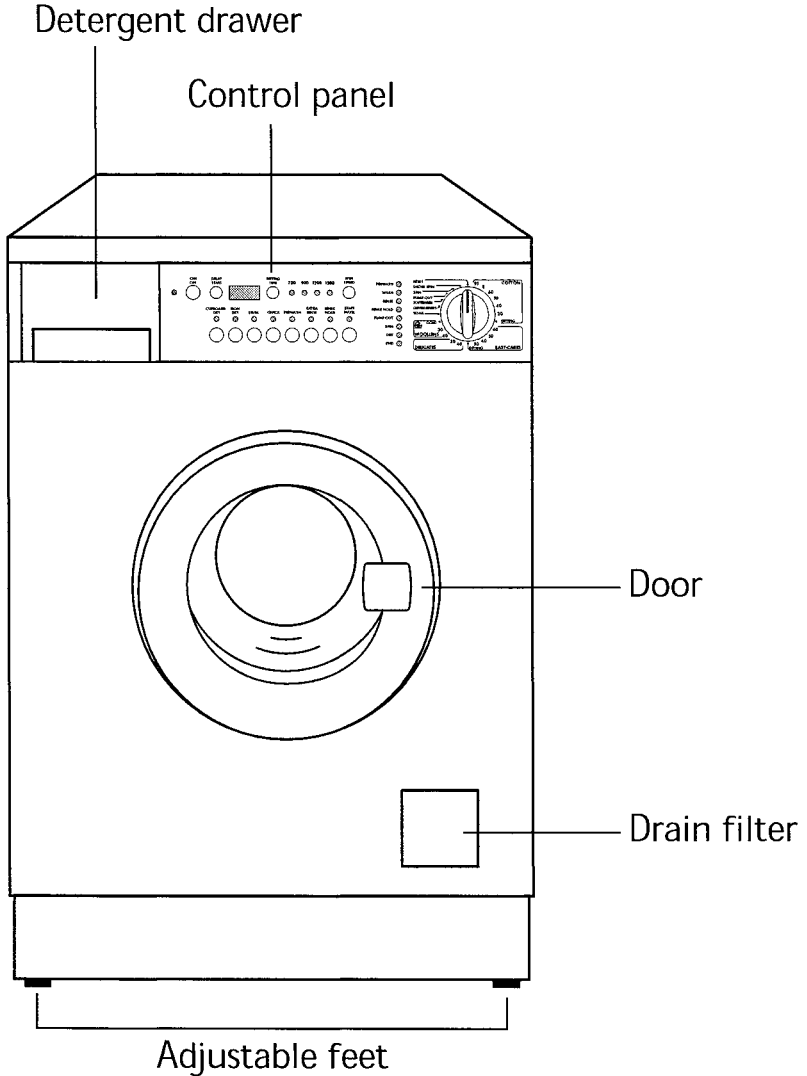

Control panel

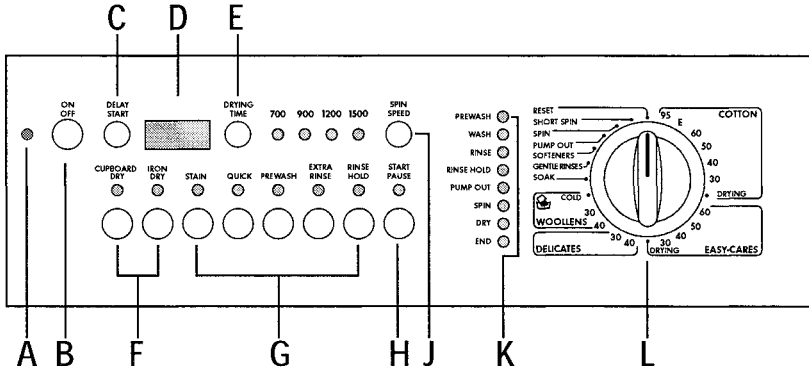

- A = Mains-on light
- B = ON/OFF button
- C = Delay start button
- D = Display
- E = Drying time button
- F = Electronic drying buttons
- G = Option buttons
- H = START/PAUSE button
- J = Spin speed button
- K = Programme progress display
- L = Programme selector dial

Programme selector dial

The programme selector determines the type of washing cycle (e.g. water level, drum movement, number of rinses, spin speed), the washing temperature and enables the required drying programme to be selected according to the type of laundry.

The selector is divided into 5 sections:

- Cotton
- Easy-cares
- Delicates
- Woollens  (hand washing)
- Special programmes

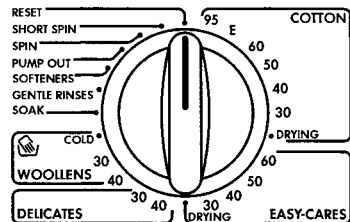

The selector dial can be turned either clockwise or anticlockwise.



Position **E** corresponds to the ENERGY SAVING programme at approx. 67 °C for normally soiled laundry, extended washing time (cannot be combined with STAIN and QUICK).

ON/OFF button

Press this button to switch the machine on. Press it again to switch the machine off.

Mains-on light

This light comes on when the ON/OFF button is pressed, and goes out when it is pressed again.

START/PAUSE button

This button has three functions:

a) Start

After having selected the required programme, press this button to start the machine; the corresponding pilot light stops flashing.

b) Pause

To interrupt a programme which is running, press the START/PAUSE button: the corresponding pilot light and the light of the programme phase which is running will start to flash.

To restart the programme from the point at which it was interrupted, **press the START/PAUSE button again.**

c) Empty out water

At the end of a programme which ends with water in the drum (RINSE HOLD option), or after the "soak" programme, press the START/PAUSE button to empty out the water: after the soak programme, the machine will empty only; after RINSE HOLD programmes, the machine will empty and spin.

DELAY START button

The wash programme can be delayed from 1 hour up to a maximum of 19 hours.

The button must be pressed after selecting the programme and before pressing the START/PAUSE button.

The figures indicating the delay appear for about 2 seconds in the display next to the button. The duration of the selected wash programme is then displayed. One minute after depressing the START/PAUSE button, the machine starts its hourly countdown.

During the last hour, the remaining time is displayed every 5 minutes. The delayed start function **cannot** be used with the SPIN or PUMP OUT programmes.

To alter or cancel the preset delay, press the START/PAUSE button, then press the DELAY START button until the required time is displayed or, if you wish to cancel the delay, until the symbol 0h is displayed.

Then press the START/PAUSE button again.

When the delay is cancelled, the display shows the duration of the wash programme previously selected.

ELECTRONIC DRYING buttons

By means of these buttons you can choose the required degree of drying for cottons and synthetics:

- CUPBOARD DRY
- IRON DRY.

The drying time is automatically adjusted by the machine: the laundry will be dried to the selected degree of dryness.

DRYING TIME button

If you wish to carry out a timed programme instead of an electronic programme push the button until the drying time you want appears in the display according to the fabrics (cotton or synthetics) you have to dry.

For **COTTON** you can select a drying time from 10 minutes to 2 hours and 10 minutes (2.10).

For **EASY-CARES** you can select a time from 10 minutes to 1 hour and 40 minutes (1.40).

Programme Option buttons

Depending on the programme, different functions can be combined. These must be selected after choosing the desired programme and before depressing the START/PAUSE button.

When these buttons are pressed, the corresponding pilot lights come on. When they are pressed again, the pilot lights go out.

If an incorrect option is selected, the pilot lights flash for about 3 seconds and the message **Err** is displayed.

STAIN

To treat heavily soiled washing or stained washing with stain remover (extended main wash with time optimised stain action phase, **not** selectable for wool or programmes with temperatures lower than 40 °C).

QUICK

By pressing this button the washing time is reduced. For use when washing lightly soiled laundry.

This option is **not** available with the wool programme.

PREWASH

The machine performs a prewash cycle at 40 °C max. The prewash cycle ends with a short spin in programmes for Cotton and Easy-cares, and with emptying of the water only for Delicates.

This option is **not** available with the wool programme.

For use when washing heavily soiled laundry.

Important: the STAIN, PREWASH and QUICK WASH options **cannot** be selected together: one automatically disables the others.

EXTRA RINSE

Can be used with all programmes **except the wool programme**. The machine performs 4 rinses instead of 3.

This option is recommended for people who are allergic to detergents and in areas where the water is very soft.

RINSE HOLD

When this button is pressed, the last rinse water is not emptied out, to prevent the fabrics from creasing. When the programme has finished, the corresponding pilot light on the programme progress display flashes to indicate that the water must be emptied out.

To empty out water:

- press the START/PAUSE button: after emptying, the machine performs the spin cycle required for the type of wash selected;
- select the PUMP OUT programme to empty out the water without spinning.

Warning! The programme selector dial must be turned first to RESET and then to programme "PUMP OUT".

This option can also be selected for the wool programme: the last rinse water is emptied out but the machine does not spin.

If the water is not emptied out, the machine automatically empties itself after 18 hours.

The RINSE HOLD option **cannot** be selected for the automatic WASHING & DRYING programme.

SPIN SPEED

Press this button to reduce the maximum speed of the final speed proposed by the machine for the selected programme.

The maximum spin speed for cotton is 1500 rpm, for easy-cares and wool 900 rpm and for delicates 700 rpm.

Display

The display shows the following information:

- if the programme selector dial is on the RESET position, **three flashing dashes** appear immediately after pressing the ON/OFF button to indicate that the machine is ready to receive instructions for the required wash programme;
- **duration of the selected wash programme**, calculated automatically on the basis of the maximum recommended load for each type of fabric.
- **Selected drying time** (max. 2 hours and 10 minutes for cotton, 1 hour and 40 minutes for easy-cares).

After the programme has started, the time remaining is updated every 10 minutes, and every 5 minutes during the last 20 minutes.

- When the programme has finished, **three flashing zeros** are displayed;
- **delayed start**, programmed using the special button (C).
The selected delay (19 hours max.) is indicated in the display. The countdown is updated every hour, and every 5 minutes during the last hour.
- **Heating phase**. A dot to the right of the figures in the display indicates that the machine is heating the water.
- **Incorrect option selection**. If an option which is not compatible with the set wash programme is selected, the message **Err** is displayed.

Programme progress display

By selecting the wash programme, the pilot lights corresponding to the various phases making up the programme come on.

After the machine has started, only the running phase pilot light stays on. When the programme has finished, the END pilot light comes on.

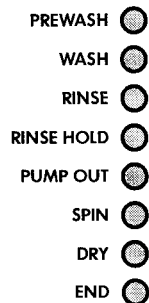

Cancelling a programme

To cancel a programme which is running, turn the programme selector dial to the RESET position: three flashing dashes will be displayed.

Warning! After a programme which ends with water in the drum (RINSE HOLD option), turn the selector dial first to RESET and then to the PUMP OUT programme.

Altering a programme which is running

To alter a programme, first set the machine to PAUSE by pressing the START/PAUSE button.

Before the machine starts the heating phase, i.e. within the first 15 minutes for cotton programmes, 10 minutes for easy-cares and delicate programmes and 5 minutes for the wool programme, the selected wash cycle can be modified.

Warning! If the programme selector dial is turned first to RESET and then to the new programme, the programme which is running is cancelled, the water is emptied out and the machine re-starts from water filling. To simply modify the programme which is running, turn the programme selector dial to the desired position (avoiding the RESET position): when the START/PAUSE button is pressed again, the machine restarts with the newly selected programme from the point at which it was interrupted.

Opening the door after the programme has started

The door can only be opened before the machine starts the heating phase (within the first 15, 10 or 5 minutes, depending on the programme selected - see paragraph above) and during the rinse phase.

Set the machine to PAUSE (by pressing the START/PAUSE button).

If the door does not open, this means that the machine is already heating, or that the water level is above the bottom edge of the door.

This prevents water from spilling out when the door is opened.

Detergent dispenser drawer

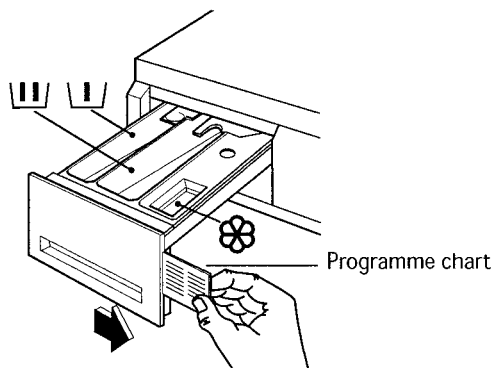

- II** Compartment for prewash or soak detergent and stain remover. The prewash or soak detergent is added at the beginning of the wash programme. The stain remover is added during the STAIN-Action phase in the main wash.
- III** Compartment for powder or liquid detergent used for main wash. It is emptied at the beginning of the wash cycle.
- ☼** Compartment for liquid additives (fabric softener, starch). It is emptied at the last rinse.

The quantity of additives must not exceed the "MAX" mark in the drawer.

Before the first wash

Before your first wash, we recommend that you run a cotton cycle at 60 °C, **without any laundry in the machine**, to remove any manufacturing residue from the drum and tub.

Pour 1/2 a measure of detergent into the dispenser drawer and start the machine.

Preparing the wash cycle

Sorting out and preparing the laundry

- Sort out the laundry according to type of fabrics and care labels (see "Types of fabric and care labels").
- Empty pockets.
- Remove any metal parts (safety pins, clips, etc.).
- To prevent the laundry from getting damaged and forming bundles, it is advisable to close zips, button up pillowcases and quilt covers and tie up loose straps such as those of aprons.
- Turn double faced items inside out (sleeping bags, anoraks, etc.)
- Turn coloured knitted fabrics, woollens and fabrics with trim inside out.
- Wash small and delicate items (baby socks, tights) inside a laundry net or in a pillow case closed with a zip, or in larger socks.
- Treat curtains with special care. Remove all metal or plastic hooks or put them in a net or a bag. We decline any responsibility in case of damage.
- Whites and coloureds must be washed separately: white items can lose their whiteness.
- New coloured fabrics often have excess dyes; it is advisable to wash them separately for the first time.
- Wash small and large items together; this improves the washing result and the laundry is better distributed during spinning.
- Shake out garments before putting them into the machine.
- Insert each garment separately.

Weight of laundry

Sort of laundry	Approximate dry weights
Bathrobes	1200 g
Work shirts	300-600 g
Quilt covers	700 g
Sheets	500 g
Blouses	100 g
Hand towels	200 g
Tea towels	100 g
Shirts	200 g
Pillowcases	200 g
Night-gowns/Pyjamas	200-250 g
Tablecloths	200-300 g
Underwear	250 g

Types of fabric and care labels

The labels on garments help you to select the most suitable wash programme. The laundry should be sorted out according to the type of fabric and the instructions indicated on care labels.

Temperatures indicated on labels are always maximum temperatures.

Cotton

Linen and cottons marked with this symbol can be washed at high temperatures.

Cotton

Linen and cottons marked with this symbol are colourfast and can be washed at 60 °C.

Cotton

Garments marked with these symbols have delicate colours, therefore the washing temperature must not exceed these values.



Synthetics (Easy-cares)

Mixed and synthetic fabrics marked with these symbols require a gentle wash programme and they must therefore be washed using the specific programme.

Delicates  

Microfibres, easy-cares or curtains marked with these symbols require a very gentle treatment.

The DELICATES programme is suitable for this type of fabric.

Woollens and particularly delicate items   

Fabrics such as wool, wool mix or silk marked with this symbol are particularly sensitive to machine washing.

The WOOLLENS programme is suitable for this type of fabric.

Fabrics marked with the  symbol (wool) can be machine washed only if the label indicates "does not felt" or "machine washable".

If the label has the symbol  (do not wash), the garments must not be machine washed!

Detergents and additives

Which detergent?....

To ensure you obtain the best wash results from your appliance, it is important to use the right detergent in your everyday wash, and only detergents recommended for use in automatic machines.

To maintain the appearance of your clothes and household textiles and to make them last longer you should use different types of detergent for different washes, whether for whites, colours or delicates.

WHITES

We recommend the Ariel product range which is biological and designed to provide excellent cleaning and stain removal even at low temperatures.



NON BIOLOGICAL

If you prefer to use a non biological detergent, which does not contain enzymes we recommend Fairy. Fairy provides good cleaning and stain removal.



COLOURED

For coloured items you should use a detergent which is designed to clean while maintaining the original colour. Ariel Color does not contain bleach and therefore helps to preserve colours.



DELICATE ITEMS

When washing delicates such as woollens, you should use a product which is specially designed to care for fine fabrics. Dreft Automatic is suitable for woollens and other delicates.



LAUNDRY BLEACH

For additional stain removal you may wish to use a product such as Ace Gentle Bleach which is used in addition to your chosen detergent. Ace is suitable for all washable fabrics including silks, woollens and coloureds.



STAIN REMOVER

For heavily soiled garments to be washed with STAIN-Action, you should use stain removers such as VANISH In-Wash, Ecover Stain Salt and GloWhite Booster.



And in which form?

Not only are there different types of detergent, but they are also available in different forms. Whether you chose a powder or liquid in traditional or compact form is to own personal choice.

TRADITIONAL POWDERS

Pour the powder directly into the dispenser drawer. Do not sprinkle powder onto clothes in the machine drum.

TRADITIONAL LIQUIDS

Liquid can be placed in the main wash compartment of the detergent drawer marked with the symbol , start the machine immediately upon placing the detergent in the dispenser drawer.

Alternatively the detergent is measured into the specially designed dosing device* which should be placed on top of the laundry, and at the back of the machine drum.

COMPACT POWDERS AND LIQUIDS

Compact detergents (or concentrates as they are also known) are available in liquid or powder form, and generally require a smaller dosage. Follow the manufacturer's instructions to ensure the most economical usage. Pour the detergent directly into the dispenser drawer, or alternatively measure the detergent into the specially designed dosing device* which should be placed on top of the laundry, and at the back of the machine drum.

* **If you use a dosing device in a washer dryer, please ensure the dosing device/ball is removed before carrying out a drying programme.**

FABRIC CONDITIONERS

These are ideal for improving "softness", and also reduce static cling on easy-cares and make ironing easier. They are available in two types:

- For example Lenor liquid fabric softener, for use in the **washing machine/washer dryer**. The liquid fabric softener should be poured into the compartment marked with the symbol . Follow the manufacturer's dosage instructions and never exceed the MAX level.



- Bounce conditioning sheets for use in a **tumble dryer**. We recommend the conditioning sheets are pinned (using a safety pin) to an article of laundry and placed in the tumble dryer.



Preparing the drying cycle

As a dryer, the machine works on the condensation principle. Therefore, **the water tap must be open and the drain hose must drain water into a sink or into the drain pipe, even during the drying cycle.**

Load

Sort of laundry	max. load (dry weight)
Linen and cottons	2.5 kg
Easy-cares	1.75 kg

Warning:

Loads of washed laundry exceeding these values must be divided before being dried, otherwise poor results will be obtained.

Garments not suitable for drying

- Particularly delicate items such as synthetic curtains, woollen and silk, garments with metal inserts, nylon stockings, bulky garments such as anoraks, bedcovers, quilts, sleeping bags and duvets must not be machine dried.
- Garments padded with foam-rubber or materials similar to foam-rubber must not be machine dried; they represent a fire hazard.
- Also, fabrics containing residues of setting lotions or hair sprays, nail solvents or similar solutions must not be machine dried in order to avoid the formation of harmful vapours.

Drying symbols on garment labels

Always look at the garment label to check whether garments can be machine dried.

The following symbols refer to drying:



Machine drying is usually possible



Normal drying (normal temperature)



Gentle drying (reduced temperature)



Do not machine dry

Garments marked with the symbol  should not be machine dried.

Duration of the drying cycle

The drying time can vary according to

- the final spin speed;
- the required degree of drying (extra dry, only for cottons, cupboard dry or iron dry);
- the type of laundry;
- the size of load.

The usual drying times are indicated in the programme chart. As you become more familiar with the appliance, you will discover the drying times that best suit your needs according to the various type of fabric. It is a good idea to make a note of these times.

Modification of the drying time or degree of drying

If you wish to modify the drying time or the degree of drying when a drying programme is running, first depress START/PAUSE button to set the machine to PAUSE. After modifying the time or the degree, depress START/PAUSE again to continue the programme.

Fibre residue

After drying fluffy fabrics, such as new towels, it is advisable to perform a gentle rinse to be sure that any residue that may remain in the tub is completely removed and does not stick to garments dried afterwards.

After each drying cycle the filter should be checked and cleaned.

Additional drying

Should the laundry still be too wet at the end of the programme, set another short drying cycle.

Warning! To prevent the formation of creases or shrinking of fabrics, avoid excessive drying.

Automatic washing and drying (NON-STOP programme)

The NON-STOP programme can be used with

- cottons, linen
- easy-cares

It cannot be used for delicate fabrics and woollens.



Warning: the maximum load sizes for NON-STOP operation - washing plus drying - are as follows:

- | | |
|---------------------|-------------|
| - cottons and linen | max 2.5 kg |
| - easy-cares | max 1.75 kg |



The drying time or degree of dryness has to be selected after choosing the wash programme.

i How to wash

Load the laundry

-  Open the door.
-  Place the laundry in the drum, one item at a time. Distribute laundry as evenly as possible. Close the door.

Add detergent and additive

-  Pull the drawer out till it stops.
-  Pour the main wash detergent into compartment **II**.

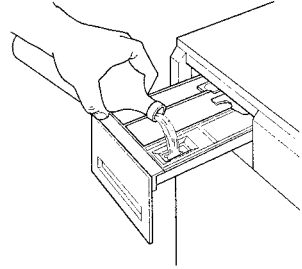
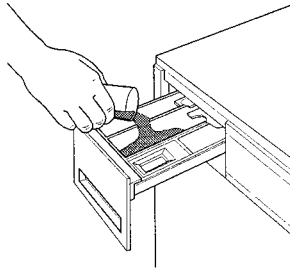



If you wish to perform a pre-wash, or a STAIN-

Action programme, pour detergent or stain remover into compartment **I**.

Important!

Do not use normal detergent for the STAIN-Action programme, always use a STAIN remover such as VANISH.

-  Pour the fabric softener into compartment  without exceeding the "MAX" mark.
-  Close the drawer, pushing it fully in.

Switching the machine on

-  To switch the machine on, press the ON/OFF button: if the programme selector dial is on the RESET position, three flashing dashes will be displayed. If the programme selector dial is positioned on a wash programme, the duration of that programme will be displayed.

ON
OFF

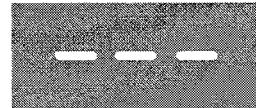
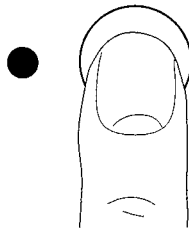

Selection of the desired wash programme

 Turn the programme selector dial to the desired position: the lights corresponding to the different phases making up the selected programme light on.

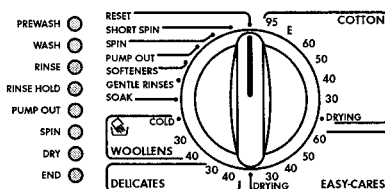

Selection of the spin speed

 To select the desired spin speed, press the SPIN SPEED button: the corresponding light comes on.

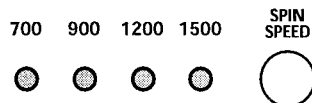

Selection of the STAIN, PREWASH or QUICK WASH option, depending on the degree of soil of the laundry and on the type of fabric.

The corresponding light comes on.

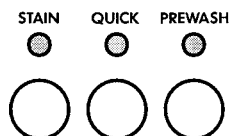

Selection of the EXTRA RINSE and/or RINSE HOLD option

The corresponding light(s) come on.

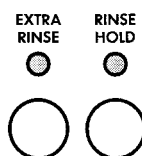

Selection of the DELAY START option

-  To delay starting of a programme, press the DELAY START button **before starting the machine**. The figures corresponding to the selected delay will be displayed for about 2 seconds, after which the duration of the selected programme will appear on the display.

DELAY
START



When the START/PAUSE button is pressed, the selected delay will again appear on the display and the machine starts its countdown.

Starting the programme

-  To start the selected programme, press the START/PAUSE button; the corresponding light stops flashing. The pilot light corresponding to the wash phase which is running comes on. After about 30 seconds the programme starts.

START
PAUSE



At the end of the programme

The machine stops automatically and three flashing zeros are displayed. The END and spin speed pilot lights, as well as the pilot light(s) corresponding to the selected option(s), stay on.



If the RINSE HOLD option has been selected, the corresponding pilot light on the programme progress display flashes to indicate that the water must be emptied out before opening the door.

The pilot light of the START button flashes and three flashing zeros are displayed.

Release of the lock is indicated by an audible signal.



Switch the machine off by pressing the ON/OFF button.



Turn the programme selector dial to RESET.



Remove the laundry from the drum.

Check that the drum is empty so as to avoid a subsequent wash being damaged by any forgotten items.



Close the water tap.



Leave the door open to prevent the formation of mildew and unpleasant smells.



i How to dry

Drying only

Warning! Do not exceed the maximum laundry loads:

- 2.5 kg for linen and cottons
- 1.75 kg for easy-cares.

The water tap must be open and the drain hose must be positioned in the sink or connected to the drain pipe.

-  Press the ON/OFF button to switch the machine on.
-  Select the drying programme (for cotton or easy-cares).
-  Press the DRYING TIME button until the time you want appears in the display (for timed drying).



DRYING
TIME





-  If you wish to carry out the electronic drying, depress the button corresponding to the degree of dryness required.

CUPBOARD
DRY











IRON
DRY



-  Press the START/PAUSE button to start the programme.
-  At the end of the cycle, turn the programme selector dial to RESET and press the ON/OFF button again to switch the appliance off.
-  Remove the laundry.

i Automatic washing and drying (NON-STOP programme)

Warning! For NON-STOP programmes, it is also essential not to exceed the maximum load sizes of 2.5 kg for cotton and 1.75 kg for easy-cares.

-  Load the laundry.
-  Add detergent and additive.
-  Switch the machine on by depressing the ON/OFF button.
-  Select the wash programme.
-  Select eventually the required options by means of the relevant buttons. If possible, do not select a spin speed lower than that proposed by the appliance to avoid a too long drying time so saving energy.
-  Select the drying time or degree of drying.
-  Start the programme by depressing the START/PAUSE button.
-  At the end of the programme, turn the selector dial to RESET and press the ON/OFF button again to switch the machine off.
-  Remove the laundry.

Programme chart

Wash programmes

Wash programme	Temp.	Fabrics	Additional functions	Max. load	Duration min.*
Whites	95 °60 °C	Cotton and linen, for example normally soiled work garments, sheets, household linen, underwear, towels.	STAIN QUICK PREWASH EXTRA RINSE RINSE HOLD SPIN SPEED	5 kg	160
E Whites ECONOMY	67 °C	Cotton and linen, for example normally to lightly soiled sheets and household linen.	PREWASH EXTRA RINSE RINSE HOLD SPIN SPEED	5 kg	160
Coloured cottons	60 °50 °C 40 °30 °C	Coloured cotton or linen fabric, shirts, underwear, towels.	STAIN QUICK PREWASH EXTRA RINSE RINSE HOLD SPIN SPEED	5 kg	135
Easy-cares	60 °50 °C 40 °30 °C	Synthetic fabrics, underwear, coloured garments, non-shrink shirts, blouses.	STAIN QUICK PREWASH EXTRA RINSE RINSE HOLD SPIN SPEED	2 kg	90
Delicates	40 °30 °C	Delicate fabrics, for example curtains.	STAIN QUICK PREWASH EXTRA RINSE RINSE HOLD SPIN SPEED	2 kg	60
Woolens 	40 °30 °C COLD	Wool, wool mix, silk.	RINSE HOLD SPIN SPEED	1 kg	60

ECONOMY

Select the economy programme "E" instead of the 95 °C programme when washing normally soiled whites; the wash is carried out at about 67 °C, with consequent energy saving. The washing phase will be slightly longer.

In compliance with EC directive 92/75, the consumption figures indicated on the energy label refer to the 60 °C wash programme for cotton.

* The programme duration is intended as a guide only. The actual wash time will vary depending on the temperature and pressure of incoming water and quantity of laundry.

Programme chart

Special programmes

Programme	Type of laundry	Programme phases	Additional functions	Max. load	Duration min.*
Soak	Heavily soiled fabrics, except wool.	Soak at 40 °C. Stop with water in drum. To empty only: press the START/PAUSE button. To empty and spin: select the desired spin speed and press the START/PAUSE button. The machine automatically empties itself after 18 hours.		5 kg	28
Gentle rinses	This programme can be used for rinsing hand washed garments.	3 rinses with liquid additive. Short spin. (700 rpm max)	EXTRA RINSE RINSE HOLD SPIN SPEED	5 kg	20
Softeners	Hand washed garments to be starched or softened.	1 rinse with liquid additive. Spin.	RINSE HOLD SPIN SPEED	5 kg	20
Pump out	For emptying out the last rinse water in programmes with the Rinse Hold option.	The water is emptied out.		/	2.5
Spin	Separate spin for all fabrics.	Spin.	SPIN SPEED	5 kg	10
Short spin	Separate spin for synthetic and delicate fabrics.	Short spin. (700 rpm max)	SPIN SPEED	2 kg	5
Reset		For cancelling the wash programme which is running.			

Programme chart

Timed Drying

Degree of drying	Type of fabric	Max. load	Spin speed	Drying time mins
Extra dry Ideal for towelling materials	Cotton and linen (bathrobes, bath towels, etc.)	2.5 kg	1200 1500	80-90 75-85
		1 kg	1200 1500	50-60 45-55
	Cotton and linen (towels, T-shirts, bathrobes)	2.5 kg	1200 1500	70-80 65-75
		1 kg	1200 1500	40-50 35-45
Cupboard dry (*) Suitable for items to put away without ironing	Easy-cares and mixed fabrics (jumpers, blouses, underwear, household linen)	1.75 kg	900	85-95
		1 kg	900	55-65
	Iron dry Suitable for ironing	Cotton and linen (sheets, tablecloths, shirts, etc.)	2.5 kg	1200 1500
1 kg			1200 1500	30-40 25-35
Easy-cares and mixed fabrics (shirts, blouses, household linen)		1.75 kg	900	70-80
		1 kg	900	40-50

(*) The CUPBOARD DRY drying programme for cotton is the reference programme for the Energy Label data, in compliance with standard EEC 92/75.

Cleaning and maintenance

After each wash

- ☞ At the end of the wash programme, pull the dispenser drawer out a little to let it dry.
- ☞ Leave the door ajar to allow air to circulate.

If the machine is not used for a prolonged period:

- ☞ Close the water tap and unplug the appliance.

Periodical cleaning

Exterior

- ☞ Clean the outside of the cabinet with soap and water only. Rinse with clean water and dry.

Important: do not use methylated spirits, solvents or similar products to clean the cabinet.

Detergent dispenser drawer

After a while, detergents and fabric softeners leave deposits in the drawer.

- ☞ Clean the drawer, from time to time, by rinsing it under a running tap. To remove the drawer from the machine, press the button in the rear left-hand corner.

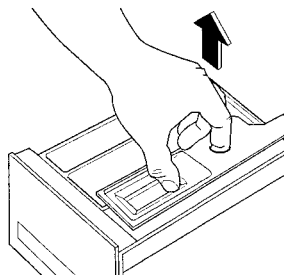
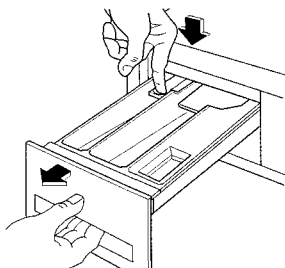



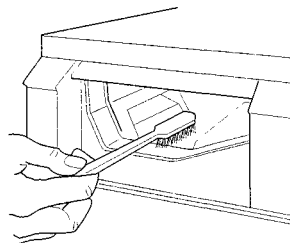

- ☞ To facilitate cleaning, the top part of the additive compartment can be removed.
- ☞ Detergent can also accumulate inside the drawer recess: clean it with an old toothbrush.
- ☞ Refit the drawer after cleaning.



Drain filter



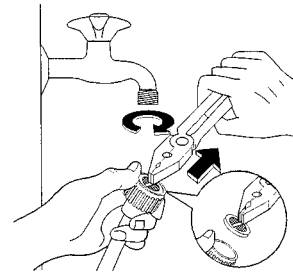
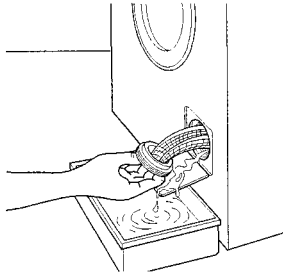
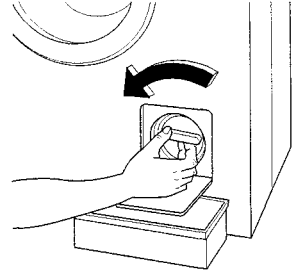
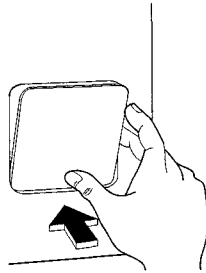

The drain filter collects threads and small objects inadvertently left in the laundry. Check regularly that the filter is clean.

-  Open the filter door.
-  Place a container under the filter and unscrew it; some water will come out of the filter.
-  Pull out the filter.
-  Clean the filter under a running tap, then refit it, screwing it fully in.



Water inlet filter

If you notice that the machine is taking longer to fill, check that the filter in the water inlet hose is not blocked.

-  Turn off the water tap.
-  Unscrew the hose from the tap and remove the filter.
-  Clean it with a stiff brush.
-  Refit the filter and screw the hose back onto the tap.

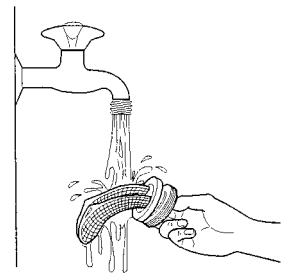

Emergency emptying out

If the water is not discharged (pump is blocked, filter or drain hose are clogged), proceed as follows to empty out the machine:

- pull out the plug from the power socket;
- close the water tap;
- if necessary, wait until the water has cooled;
- place a bowl on the floor;
- put the drain hose end into the bowl and let the water out.

Should it not be possible to have access to the drain hose because, for example the appliance is built in the kitchen furniture, slightly loosen the drain filter after placing a bowl on the floor to let the water come out slowly.

At the end screw the filter again.

Frost precautions

If the machine is installed in a place where the temperature could drop below 0 °C, proceed as follows:

- Close the water tap and unscrew the water inlet hose from the tap.
- Place the end of the drain hose and the inlet hose in a bowl placed on the floor.
- Select the "PUMP OUT" programme and run it until the machine stops.
- Turn the programme selector dial to RESET.
- Press the ON/OFF button to switch the machine off.
- Remove the plug from the power socket.
- Screw the water inlet hose back on and put the drain hose back in its place.

By doing this, any water remaining in the machine is removed, avoiding the formation of ice and, consequently, damage to the appliance.

When you use the machine again, make sure that the ambient temperature is above 0 °C.

Something not working?

i If, during the spin cycle, the machine makes an unusual whistling noise, different from the noise made by traditional washing machines, this is due to a new type of motor.



If water is not visible in the drum, this is due to the modern technology of new washing machines that use less water than traditional machines.

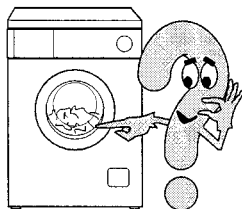

Troubleshooting

If a problem arises, you can try to solve it yourself following the instructions below.

If you call out an engineer when one of the following problems arises, or to repair a fault due to incorrect use, the call-out will be charged even if requested within the guarantee period.

During machine operation the following alarm codes may be displayed:

- **E00:** problem with the water supply
- **E10:** problem with water draining
- **E20:** door open

Once the problem has been eliminated, press the START/PAUSE button to restart the programme. If after all checks, the problem persists, contact your local AEG Service Force Centre.

Problem	Possible cause	Solution
The machine does not work	The ON/OFF button has not been depressed.	Depress the button.
	The main electrical fuse has blown.	Replace the fuse.
	The door is not properly closed (E20).	Close the door; the click of the lock should be heard.
	The plug is not connected.	Insert the plug.
	The START button has not been pressed.	Press the button.
	The DELAY START option has been selected.	Check the selected delay on the display.

Problem	Possible cause	Solution
The machine does not fill	The water tap is closed (E00).	Open the water tap.
	The water inlet hose is squashed or kinked (E00).	Check the whole length of the hose and remove the kink.
	The small filter of the water inlet hose is clogged (E00).	Clean the filter.
	The door is not properly closed (E20).	Close the door.
The machine fills then empties immediately	The end of the drain hose is too low.	Place the hose at the right height (see Installation section).
The machine does not empty and/or does not spin	The drain hose is squashed or kinked (E10).	Check the whole length of the hose and remove the kink.
	The drain filter or the drain hose are clogged (E10).	Clean the filter or check the hose.
	The RINSE HOLD option (stop with water in drum) has been selected.	Empty out the water by pressing the START button or selecting the PUMP OUT programme.
	The laundry is not evenly distributed inside the drum.	Redistribute the laundry manually in the drum.
There is water on the floor	Too much detergent has been used.	Measure detergent according to the manufacturer's instructions.
	An unsuitable detergent has been used that creates too much foam.	Use a suitable washing machine detergent.
	One of the connectors on the water inlet hose is leaking.	Check that the hose is firmly screwed on at both ends.
	The drain filter has not been properly screwed on after cleaning.	Fully screw the filter into place.

Problem	Possible cause	Solution
The machine vibrates or is noisy	The transit bolts have not been removed.	Check that the machine has been unpacked as described in the Installation section.
	The feet have not been adjusted.	Carefully level the machine.
	There is little laundry in the drum.	Correct operation of the machine is not affected.
The door will not open	The programme is still running.	Wait until the end of the programme before opening the door.
	The door lock has not yet released.	Wait about 2 minutes for the door lock to release.
	The water level is above the bottom edge of the door.	Before opening the door, the water must be emptied out.
	The machine is heating the water.	Wait until the end of the heating phase.

Problem	Possible cause	Solution
<p>Spinning starts late or the machine does not spin</p>	<p>The unbalance detection device that prevents excessive vibration during spinning has cut in.</p>	<p>If the laundry is not evenly distributed inside the drum at the beginning of the spin cycle, the machine detects this and tries to redistribute it more evenly by means of a few drum rotations.</p> <p>Only when the laundry is more evenly distributed will the spin cycle be performed, at a lower speed, if the laundry is not evenly distributed.</p> <p>If, after about 15 minutes, the laundry is still tangled, the machine will not spin. Therefore, if the laundry is still wet at the end of the cycle, it is advisable to redistribute it manually inside the drum and to select the spin programme again.</p>
<p>The machine will not dry or the laundry is not dry enough</p>	<p>The water tap is not open (E00).</p> <p>The drain filter is clogged.</p> <p>The drying time or degree of drying has not been selected.</p> <p>An appropriate drying time has not been chosen.</p> <p>There is too much laundry inside the appliance.</p>	<p>Open the water tap.</p> <p>Clean the filter.</p> <p>Select the required function.</p> <p>Select the appropriate drying time suitable for the required degree of drying, according to the type of fabric (cottons or easy-cares).</p> <p>Reduce the load.</p>

Unsatisfactory washing results

If the laundry looks grey and lime scale is found in the drum

- Too little detergent has been used.
- An unsuitable detergent has been used.
- Stubborn stains have not been treated prior to washing.
- The programme/temperature has not been correctly selected.

If grey stains remain on the laundry

- Laundry stained with ointments, grease or oil has been washed with an insufficient amount of detergent.
- The temperature selected for the wash programme was too low.
- Fabric softener - especially the concentrated type - has come into direct contact with the laundry. Wash these stains immediately and pour fabric softener carefully.

Foam is still visible even after the last rinse

- Modern detergents often produce foam, even in the last rinse. However the laundry has been completely rinsed.

White residue is left on the laundry

- This is due to insoluble components in modern detergents and is therefore not the result of insufficient rinsing. Shake or brush the laundry. In future, it may be better to turn garments inside out before washing them. Check the choice of detergent; try using liquid detergents.

Technical data

Height x Width x Depth	84x60x57 cm
Depth with door opened	96.5 cm
Height adjustment	± 13 mm approx.
Net weight	83 kg approx.
Load (depending on programme)	5 kg max.
Use	domestic
Drum speed during washing	max. 55 rpm
Drum speed during spinning	1500/1200/900/700 rpm
Water pressure	1 - 10 bar (=10-100N/cm ² = 0.1-1.0Mpa)



This appliance complies with the following EC directives:

- 73/23/EEC of 19.2.1973 "Low voltage directive", including directive 93 / 68 / EEC
- 89/336/EEC of 3.5.1989 "Electromagnetic Compatibility Directive".

Service & Spare Parts

If after carrying out the necessary checks there is still a fault with your appliance please contact your local AEG Service Force Centre.

In guarantee customers should ensure that the suggested checks in the "Troubleshooting" section have been made as the engineer will make a charge if the fault is not a mechanical or electrical breakdown.

Please note that proof of purchase is required for in-guarantee service calls.

Service & Spare Parts

If you require a service engineer or wish to purchase spare parts, contact your local AEG Service Force Centre, by telephoning:

0990 929 929

Help us to help you

Please determine your type of enquiry before telephoning. When you contact us we need to know:

1. Your name, address and post code.
2. Your telephone number.
3. Clear and concise details of the fault.
 - What is the fault?
 - When does the fault occur?
 - Does the multi-display issue an error-message (E and a number)?
4. The model, production number and production identification number.
5. Date of purchase.

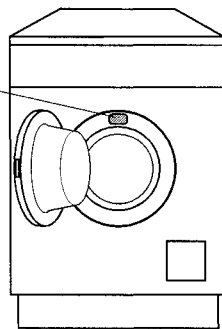
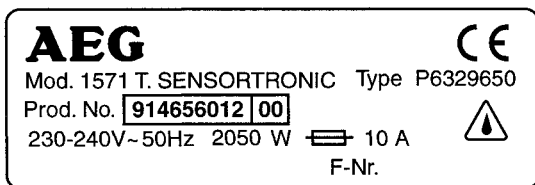

This information can be found on the rating plate, so you have these numbers to hand we recommend you write them below.

Prod. No.

F-No.

Customer care

For general enquiries regarding your AEG appliance, or further information on AEG products please contact our Customer Care Department.

Customer Care Department
AEG Domestic Appliances Limited
P.O. Box 47
Newbury
Berkshire RG14 5XL
Tel: 01635 572700
Fax: 01635 42970

Guarantee Conditions

AEG offer the following guarantee to the first purchaser of this appliance.

1. The guarantee is valid for 12 months commencing when the appliance is handed over to the first retail purchaser, which must be verified by purchase invoice or similar documentation.

The guarantee does not cover commercial use.

2. The guarantee covers all parts or components which fail due to faulty workmanship or faulty materials. The guarantee does not cover appliances where defects or poor performance are due to misuse, accidental damage, neglect, faulty installation, unauthorised modification or attempted repair, commercial use or failure to observe requirements and recommendations set out in the instruction book.

This guarantee does not cover such parts as light bulbs, removable glassware, dust bags or filters.

3. Should guarantee repairs be necessary the purchaser must inform the nearest customer service office (AEG's service or authorised agent). AEG reserves the right to stipulate the place of the repair (i. e. the customer's home, place of installation or AEG workshop).
4. The guarantee or free replacement includes both labour and materials.
5. Repairs carried out under guarantee do not extend the guarantee period for the appliance. Parts removed during guarantee repairs become the property of AEG.
6. The purchaser's statutory rights are not affected by this guarantee.

European Guarantee

If you should move to another country within Europe then your guarantee moves with you to your new home subject to the following qualifications:

- The guarantee starts from the date you first purchased your product.
- The guarantee is for the same period and to the same extent for labour and parts as exist in the new country of use for this brand or range of products.
- This guarantee relates to you and cannot be transferred to another user.
- Your new home is within the European Community (EC) or European Free Trade Area.
- The product is installed and used in accordance with our instructions and is only used domestically, i.e. a normal household.
- The product is installed taking into account regulations in your new country.

Before you move please contact your nearest Customer Care Centre, listed below, to give them details of your new home. They will then ensure that the local Service Organisation is aware of your move and able to look after you and your appliance.

France	Senlis	+33 (0) 44 62 29 29
Germany	Nürnberg	+49 (0) 911 323 2600
Italy	Pordenone	+39 (0) 1678 47053
Sweden	Stockholm	+46 (0) 8 738 7910
UK	Newbury	+44 (0) 1653 572700

Instructions for installation and electrical connection



Safety instructions for the installer

- This appliance is heavy, care should be taken when moving it.
- When unpacking the appliance, check that it is not damaged. If in doubt, do not use it and contact the retailer.
- All internal packing must be removed before using the appliance. Serious damage may be caused to the machine or adjacent furniture if the protective transit devices are not removed or are not completely removed. Refer to the relevant paragraph.
- Any electrical work required to install this appliance must be carried out by a qualified electrician.
- Any plumbing work required to install this appliance must be carried out by a qualified plumber.
- After having installed the machine, check that it is not standing on its electrical supply cable.
- If the appliance is placed on a carpeted floor, ensure that air can circulate freely between the adjustable feet and the floor.
- The installation should comply with local water authority and building regulations requirements.
- Should the appliance power supply cable need to be replaced, this should be carried out by our Service Force Centre.
- This appliance should be connected to a cold water supply only.

Dimensions of the appliance

Front view and side view

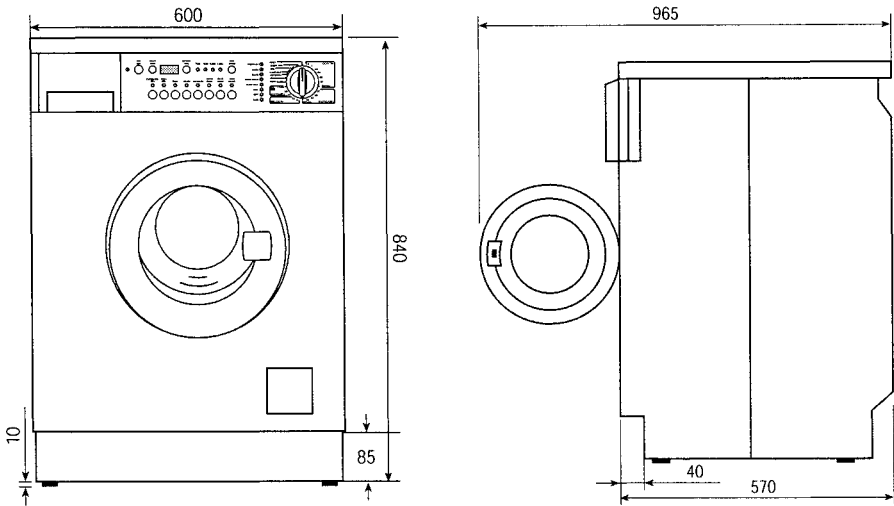

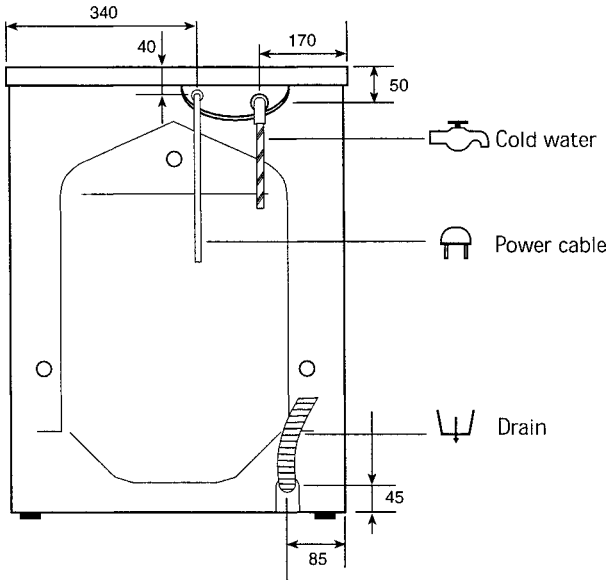

Rear view





Installation

Unpacking

 All transit bolts and packing must be removed before using the appliance.

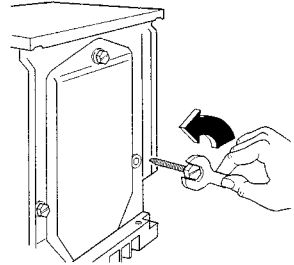
 Using a spanner, unscrew and remove the rear right-hand bolt and lay the machine on its back, taking care not to squash the hoses. This can be avoided by placing one of the corner packing pieces between the machine and the floor.



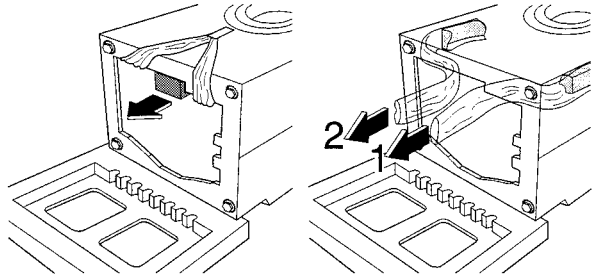

 Remove the polystyrene block from the bottom of the machine and release the two plastic bags by removing the adhesive strip.

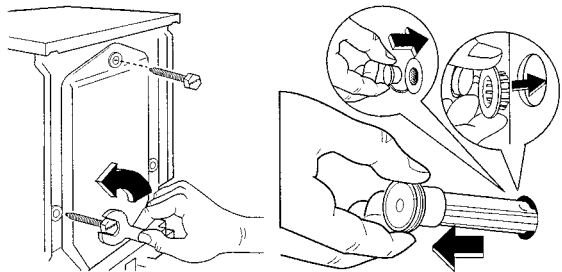

 Carefully remove the right-hand bag (1) then the left-hand bag (2) by pulling them towards the centre of the machine.

 Set the machine upright and remove the two remaining bolts from the back.



 Pull out the three plastic spacers from the holes into which the bolts were fitted.

 Plug the open holes with the plugs which you will find in the plastic bag containing the instruction booklet.

You are advised to keep all transit devices so that they can be refitted if the machine ever has to be transported again.

Positioning

Install the machine on a flat hard floor.

Make sure that air circulation around the machine is not impeded by carpets, rugs etc.

- Before placing it on small tiles, apply a rubber coating.
- Never try to correct any unevenness in the floor by putting pieces of wood, cardboard or similar materials under the machine.
- If it is impossible to avoid positioning the machine next to a gas cooker or coal-burning stove, an insulating panel (85x57 cm) covered with aluminium foil on the side facing the cooker or stove, must be inserted between the two appliances;
- The machine must not be installed in rooms where the temperature can drop below 0.
- The water inlet hose and the drain hose must not be kinked.
- Please ensure that when the appliance is installed, it is easily accessible for the engineer in the event of a breakdown.

Levelling

Carefully level by screwing the adjustable feet in or out. Never place cardboard, wood or similar materials under the machine to compensate for any unevenness in the floor.

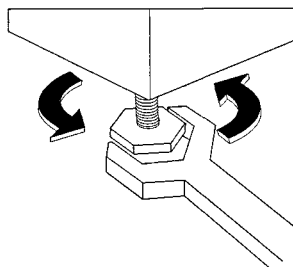

Water inlet (cold water connection only)

Before connecting the hose be sure to fit the mesh filter «A» supplied as per diagram.

Installation should comply with local water authority and building regulations' requirements.

Set the hose correctly by loosening the ring nut. After positioning the inlet hose, be sure to tighten the ring nut again to prevent leaks.

Do not connect to a hot water supply.

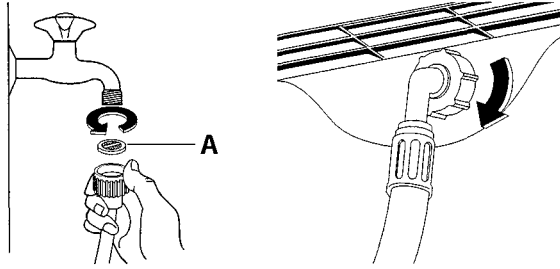

Water drainage

The appliance drain hose should hook into a standpipe, the hook in the drain hose is formed using the plastic "U-Piece" supplied. The standpipe should have an internal diameter of approximately 38 mm (see diagram) thus ensuring there is an air break between the drain hose and standpipe.

When discharging into a standpipe ensure that the top of the curve in the hose end is no more than 90 cm (35.4") and no less than 60 cm (23.6") above floor level.

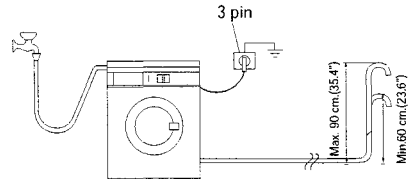

The upright standpipe should have a minimum length of 30 cm (12") from the bottom of the elbow to the top of the pipe (see diagram). Make sure that it is designed in such a way that the end of the drain hose cannot be covered with water.

Longer drain hoses are available in lengths of 2.7 and 4 metres from your AEG Service Force Centre.

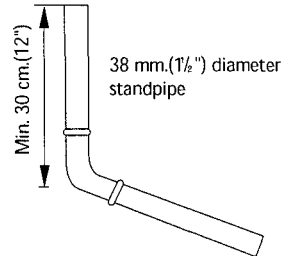

If you intend the drain hose from the machine to empty into a sink, make sure that the sink is empty and the plug hole is not blocked. Use the plastic "U -Piece" supplied.

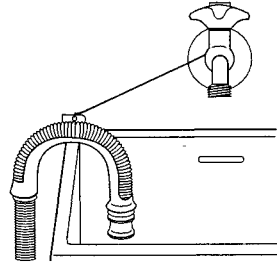

Important

Before connecting up the machine to new pipework or to pipework that has not been used for some time, run off a reasonable amount of water to flush out any debris that may have collected in the pipes.

In the interest of the environment

Washing machines and dish-washers should be connected to the FOUL drainage system, the water will then be taken to a sewage works for treatment before being discharged safely into a river.

It is essential that these appliances are not connected to the surface water drainage system as this water is discharged directly into a river or stream and may cause pollution.

If you require any further advice please contact your local authority drainage department.

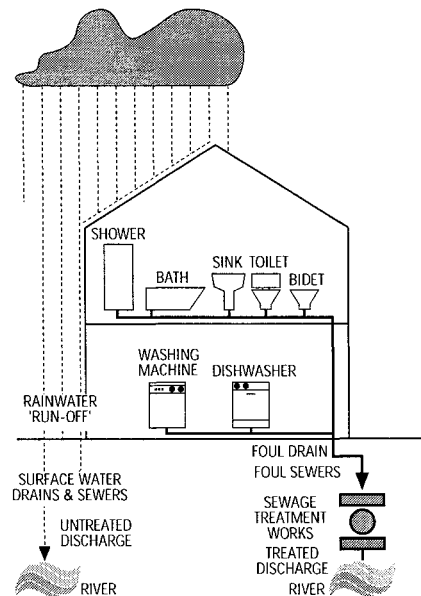

Electrical connections



WARNING: THIS APPLIANCE MUST BE EARTHED.

The manufacturer declines any liability should this safety measure not be observed.

If the plug that is fitted to your appliance is not suitable for your socket outlet, it must be cut off and the appropriate plug fitted.

Remove the fuse from the cut off plug.

The cut off plug should then be disposed of to prevent the hazard of shocks in case it should be plugged into a 13 Amp socket in another part of your home.

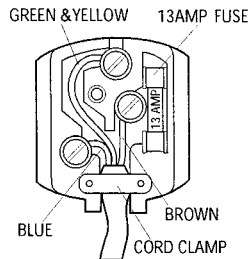

Important

The wires in the mains lead are coloured in accordance with the following code:

Green and Yellow	- Earth
Blue	- Neutral
Brown	- Live

If you fit your own plug, the colours of the wires in the mains lead of your appliance may not correspond with the markings identifying the terminals in your plug, proceed as follows:

Connect the green and yellow (earth) wire to the terminal in the plug which is marked with the letter «E» or the earth symbol \perp or coloured green and yellow.

Connect the blue (neutral) wire to the terminal in the plug which is marked with the letter «N» or coloured black.

Connect the brown (live) wire to the terminal in the plug which is marked with the letter «L» or coloured red.

The plug moulded on to the lead incorporates a fuse. For replacement, use a 13 Amp BS1363A fuse. Only ASTA or BSI approved fuses should be used.

The plug must not be used if the fuse cover/carrier is lost. The cover/carrier is indicated by the coloured insert at the base of the plug.

A replacement cover/carrier must be obtained from your local AEG Service Centre.

Permanent connection

In the case of a permanent connection it is necessary that you install a double pole switch between the appliance and the electricity supply (mains), with a minimum gap of 3 mm between the switch contacts and of a type suitable for the required load in compliance with the current electrical regulations.

The switch must not break the yellow and green earth cable at any point.

This operation has only to be performed by a qualified electrician.

AEG Hausgeräte AG
Postfach 1036
D-90327 Nürnberg 1

© Copyright by AEG

124.974.360-01-0798

AEG Domestic Appliances Ltd

Customer Care Department
55-77 High Street
Slough
Berkshire SL1 1DZ

Telephone: 08705 350350